

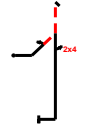

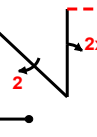

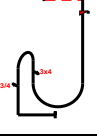
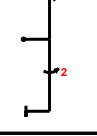
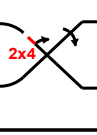

BAeA Default Free Known

		2021							Form A	
		Pilot ID							Flight #	
		CIVA Advanced Free Known								
No	Symbol	Cat. No.	K	Total K	Grade	Pos	Remarks	Item	K	Grade
1		5.3.2.1 9.1.2.2 9.4.5.2	24 6 5	Fig A 35	.			Pos.	30	
								Harm.	0	
2		1.3.14.1 9.1.1.2 9.2.4.4 9.4.1.2	22 8 9 9	Fig C 48	.			Fig K	Total K	
								320	350	
3		8.8.1.4 9.12.1.4 9.4.1.3 9.1.5.3	18 7 12 6	43	.			Penalties		
								Too Low		
4		5.2.1.1 9.2.5.4	17 9	26	.			Too High		
								Interruptions		
5		7.3.2.1 9.4.2.2 9.1.2.4	14 7 10	Fig E 31	.			Insertions		
								Trg Violation		
6		7.5.5.3 9.1.3.6 9.1.2.6 9.1.3.1 9.8.3.1	15 10 12 2 3	42	.			Wing Rocks		
								Disqual Fig		
7		7.2.2.1 9.2.3.6 9.9.3.4	6 12 11	Fig B 29	.			Other(note...)		
								Final Freestyle		
8		7.2.3.3 9.9.3.6	6 14	20	.			Duration	Min	Sec
9		8.8.6.1 9.8.1.1 9.1.5.2	21 7 4	Fig D 32	.			Judges Details		
								Signature		
10		2.1.3.1	14	14	.			Name		
								Number		

Pilot

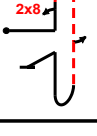
A/C

BAeA Default Free Known



2021		Form B
Pilot ID	CIVA Advanced Free Known	Flight #

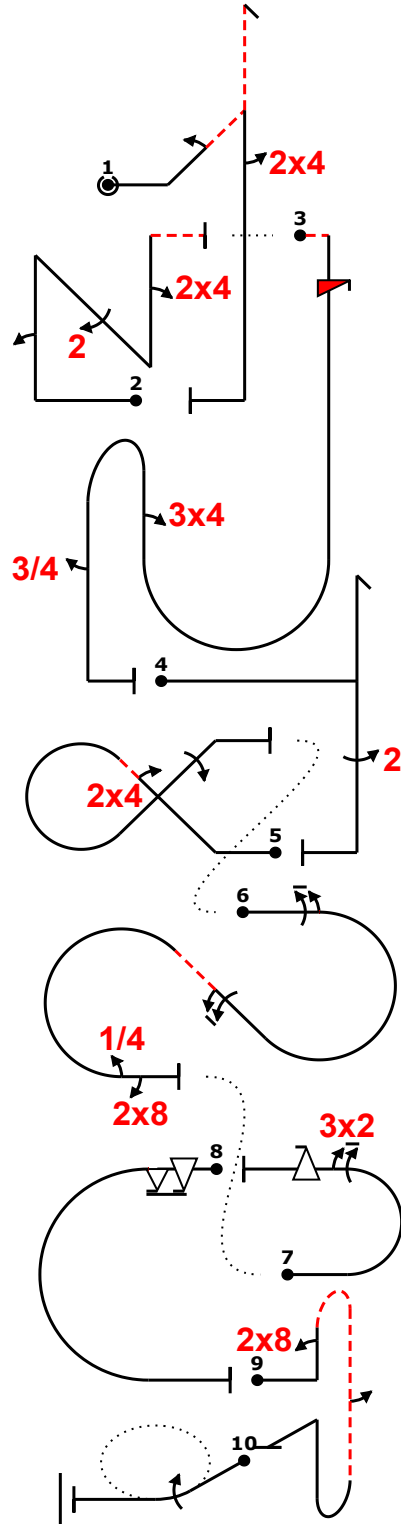
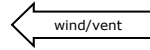

Power			
Fig	Aresti	K	
1 A	5.3.2.1	24	35
	9.1.2.2	6	
	9.4.5.2	5	
2 C	1.3.14.1	22	48
	9.1.1.2	8	
	9.2.4.4	9	
	9.4.1.2	9	
3	8.8.1.4	18	43
	9.12.1.4	7	
	9.4.1.3	12	
	9.1.5.3	6	
4	5.2.1.1	17	26
	9.2.5.4	9	
5 E	7.3.2.1	14	31
	9.4.2.2	7	
	9.1.2.4	10	
6	7.5.5.3	15	42
	9.1.3.6	10	
	9.1.2.6	12	
	9.1.3.1	2	
	9.8.3.1	3	
7 B	7.2.2.1	6	29
	9.2.3.6	12	
	9.9.3.4	11	
8	7.2.3.3	6	20
	9.9.3.6	14	
9 D	8.8.6.1	21	32
	9.8.1.1	7	
	9.1.5.2	4	
10	2.1.3.1	14	14
Total K = 320 (max K = 320)			

"@A" 2dh24.....' 2> "@C" +'2pn(' ,22'),24- (3,0) 7%-is.....18b(.....,34'')',3'+..... ~++h''22.''' "@E" ,|"24g,1 (-6,13) 4% ...
61ac(6)4,8+..... (4,15) "@B" m,32;f 10% ""6fa+ "@B" ""+ "8pbb(.....2'') 1j1

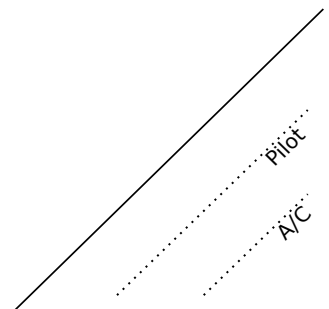

BAeA Default Free Known



2021		Form C
Pilot ID	CIVA Advanced Free Known	
		Flight #

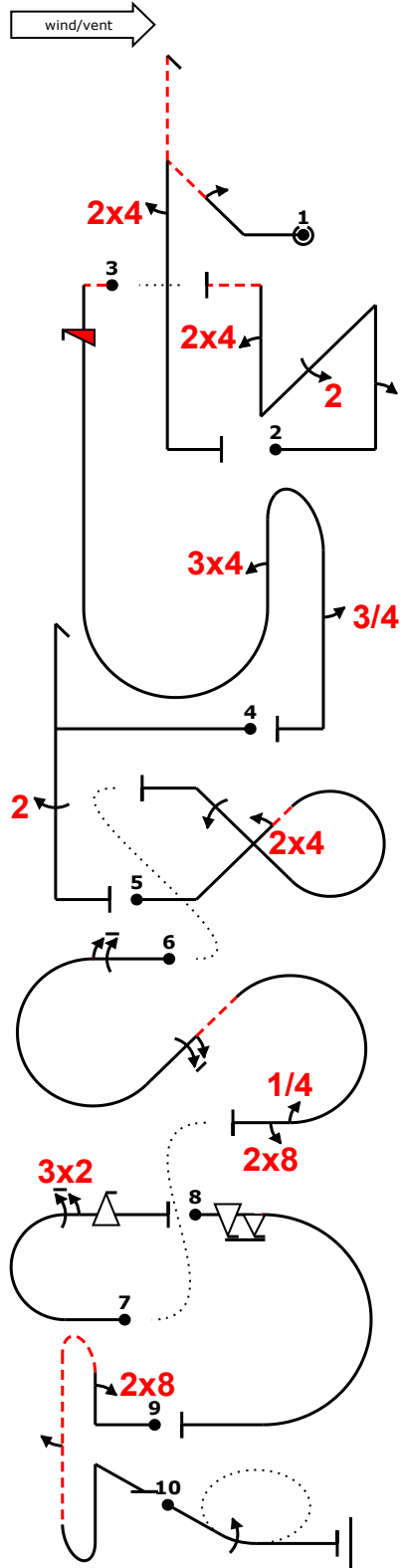

"@A" 2dh24.....' 2> "@C" +'2pn(' ,22'),24- (3,0) 7%-1s.....18b(.....,34')',3'+.....~++++h''22.'" "@E" ,|"24g,1 (-6,13) 4% ...
61ac(6)4,8+..... (4,15) "@B" m,32;f 10% ""6fa+ ""@B" ""+ ""8pbb(.....2'') 1j1

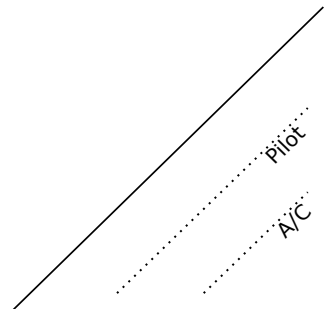

BAeA Default Free Known



CIVA	Advanced	2021
Free Known		

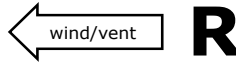

Figure K 320	Judges Name	Flight #
Total K 350	Signature	Number

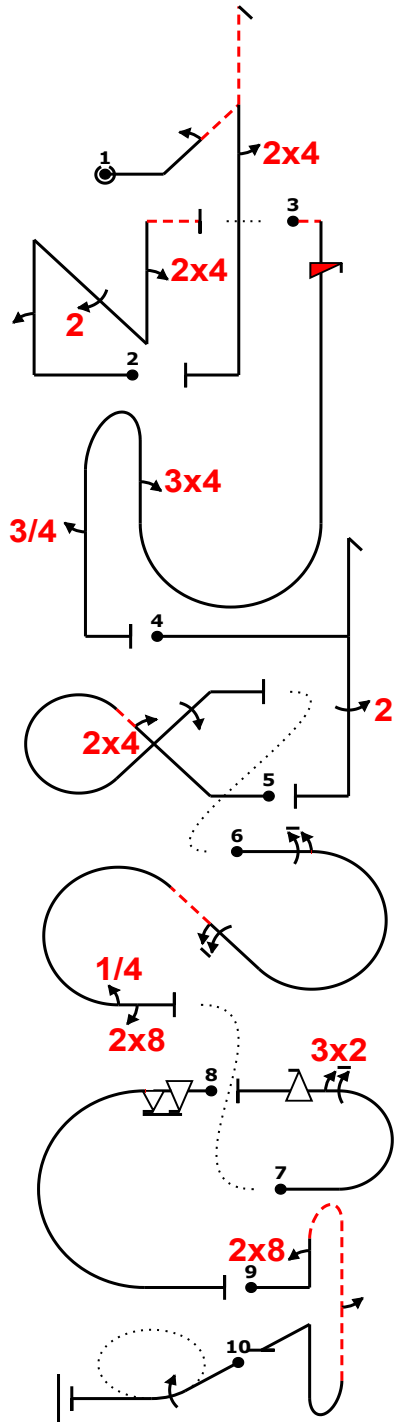

Fig	Grade	Pos	Remarks
1	.		
2	.		
3	.		
4	.		
5	.		
6	.		
7	.		
8	.		
9	.		
10	.		

Positioning	.
30	

Too Low		Trg Violation	
Too High		Wing Rocks	
Interruptions		Disqual Fig	
Insertions		Other(note...)	

"@A" 2dh24.....' 2> "@C" +'2pn(' ,22'),24- (3,0) 7%1s.....'18b(.....34')',3'+~++h''22...' '@E" ,|"24g,1 (-6,13) 4%6iac(6)4,8+(4,15) "@B" m,32;f 10% "6fa+ "@0" +'.....8pb b('.....2''') 1j1

Fig 1 A	K	Fig 2 C	K	Fig 3	K	Fig 4	K	Fig 5 E	K	Fig 6	K	Fig 7 B	K	Fig 8	K	Fig 9 D	K	Fig 10	K
5.3.2.1	24	1.3.14.1	22	8.8.1.4	18	5.2.1.1	17	7.3.2.1	14	7.5.5.3	15	7.2.2.1	6	7.2.3.3	6	8.8.6.1	21	2.1.3.1	14
9.1.2.2	6	9.1.1.2	8	9.12.1.4	7	9.2.5.4	9	9.4.2.2	7	9.1.3.6	10	9.2.3.6	12	9.9.3.6	14	9.8.1.1	7		
9.4.5.2	5	9.2.4.4	9	9.4.1.3	12			9.1.2.4	10	9.1.2.6	12	9.9.3.4	11			9.1.5.2	4		
		9.4.1.2	9	9.1.5.3	6					9.1.3.1	2								
										9.8.3.1	3								
	35		48		43		26		31		42		29		20		32		14

Pilot:

A/C:

BAeA Default Free Known



CIVA	Advanced	2021
Free Known		

Figure K
320
Total K
350

Judges Name	
Signature	Number

Flight #

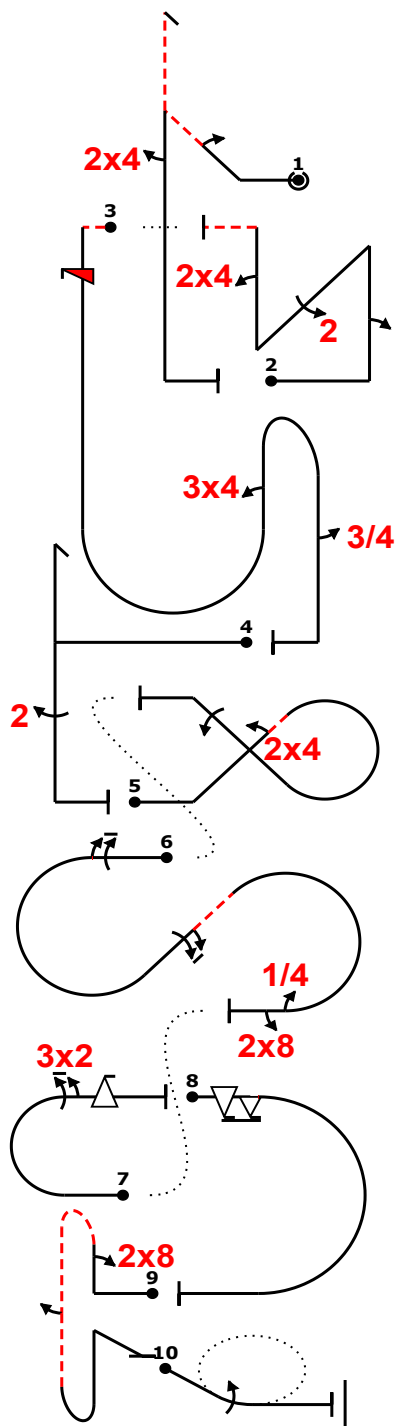
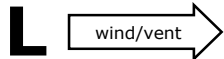

Fig	Grade	Pos	Remarks
1	.		
2	.		
3	.		
4	.		
5	.		
6	.		
7	.		
8	.		
9	.		
10	.		

Positioning	
30	.

Too Low		Trg Violation	
Too High		Wing Rocks	
Interruptions		Disqual Fig	
Insertions		Other(note...)	

"@A" 2dh24.....' 2> "@C" +'2pn(' ,22'),24- (3,0) 7%is.....'18b(' ,34')',3'+ ~++h' '22...' '@E" ,|"24g,1 (-6,13) 4%6iac(6)4,8+.....(4,15) "@B" m,32;f 10%6fa+ "@0" +'.....8pb b('.....2')' 1j1

Fig 1 A	K	Fig 2 C	K	Fig 3	K	Fig 4	K	Fig 5 E	K	Fig 6	K	Fig 7 B	K	Fig 8	K	Fig 9 D	K	Fig 10	K
5.3.2.1	24	1.3.14.1	22	8.8.1.4	18	5.2.1.1	17	7.3.2.1	14	7.5.5.3	15	7.2.2.1	6	7.2.3.3	6	8.8.6.1	21	2.1.3.1	14
9.1.2.2	6	9.1.1.2	8	9.12.1.4	7	9.2.5.4	9	9.4.2.2	7	9.1.3.6	10	9.2.3.6	12	9.9.3.6	14	9.8.1.1	7		
9.4.5.2	5	9.2.4.4	9	9.4.1.3	12			9.1.2.4	10	9.1.2.6	12	9.9.3.4	11			9.1.5.2	4		
		9.4.1.2	9	9.1.5.3	6					9.1.3.1	2								
										9.8.3.1	3								
	35		48		43		26		31		42		29		20		32		14

Pilot:

A/C:

BAeA Default Free Known

